

## SERIES N

Maximum torque: up to 2 000 Nm – Bores: up to 65 mm

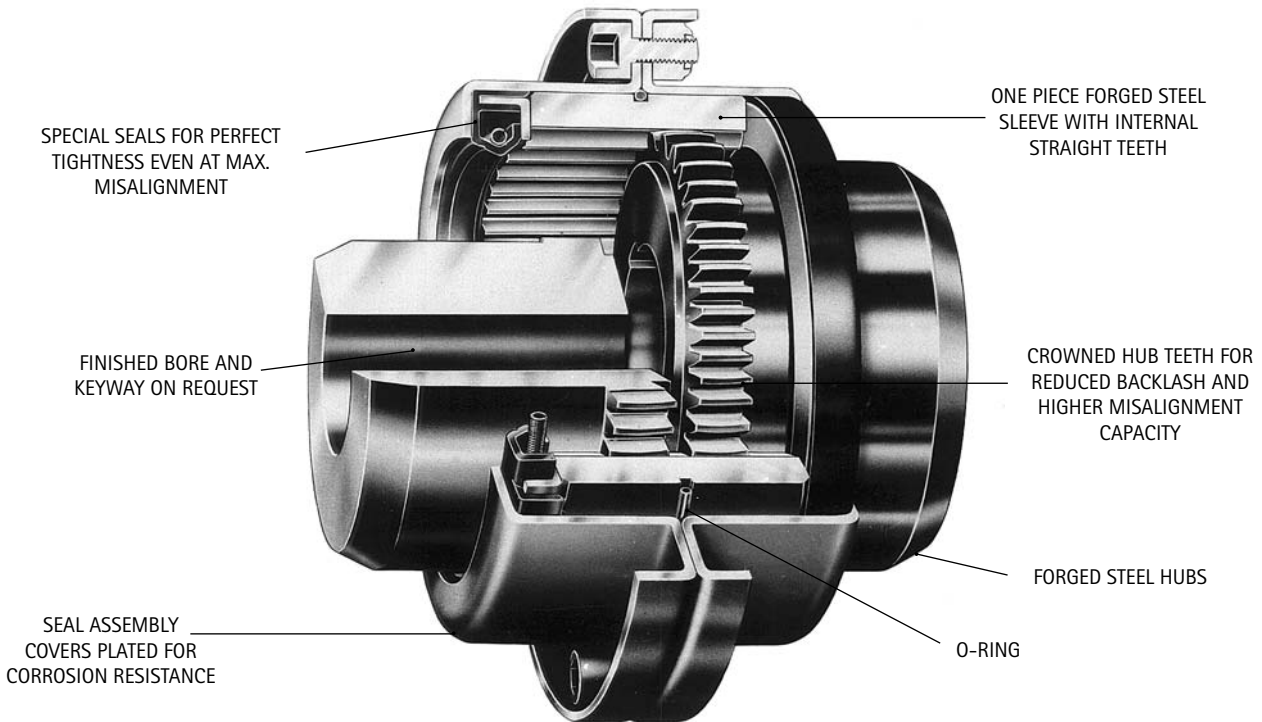

### FEATURES





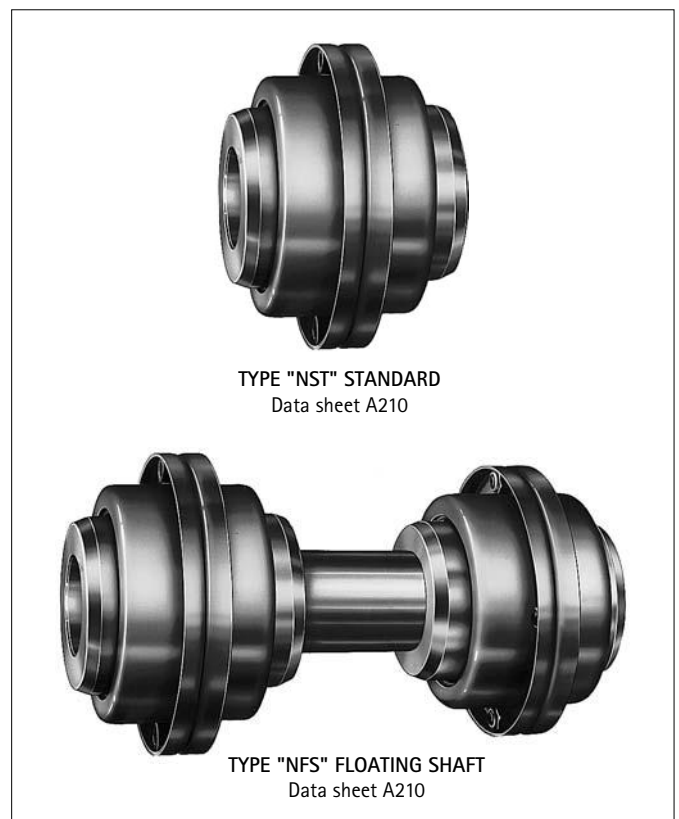

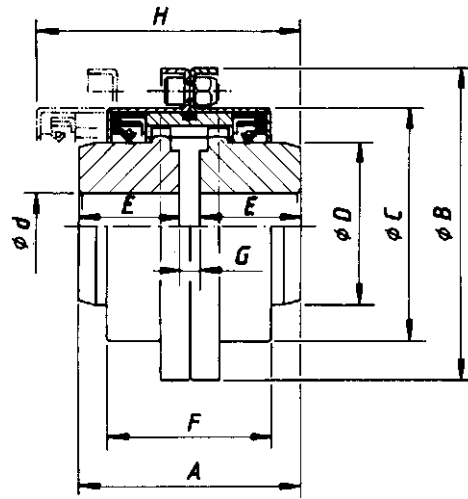

The ESCOGEAR couplings of the series N distinguish themselves by:

- maximum bores defined in function of standardized shaft diameters according to ISO and IEC.
- reduced outside dimensions and weights from which result very small axial load and thrust on the connected shafts.
- a sufficiently balanced coupling for the maximum indicated speeds, all the components being machined.
- easy installation - no special tooling is required.
- an absolute reliability and minimum maintenance.
- a perfect homocinetic torque transmission.









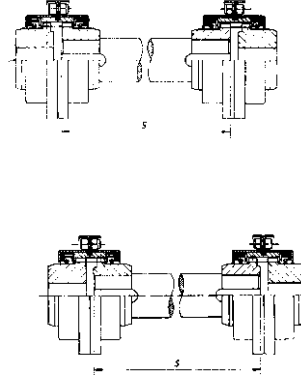
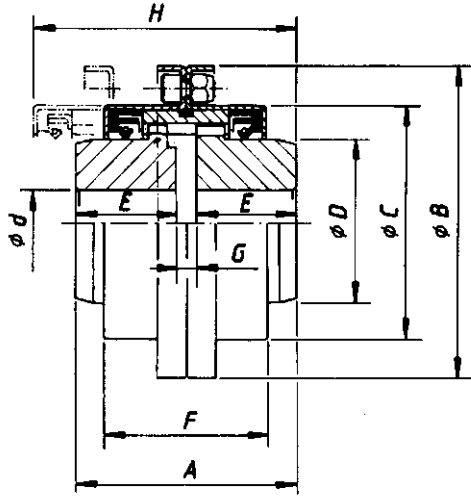



∠ max. 1,5°

 ← A150			Type NST				
			25	38	45	65	
	1	∅ max.	mm	25	38	45	65
		∅ min.	mm	0	0	0	26
	2	Tn	Nm	200	450	800	2000
		Tp		400	900	1600	4000
		tr/min omw/min rpm min <sup>-1</sup>		6300	4800	4100	3000
	—	degré graad degree grad		2x0,75	2x0,75	2x0,75	2x0,75
	—	mm		0,1	0,11	0,13	0,15
	4	J (WR <sup>2</sup> )	kgm <sup>2</sup>	0,0004	0,0013	0,0026	0,0102
	5	kg		0,85	1,81	2,97	7,23
	6	dm <sup>3</sup>		0,01	0,02	0,03	0,05
mm: ±	A	mm		58	75	95	135
	B	mm		76,5	94	109	134,5
	C	mm		57,5	74,5	86	111,5
	D	mm		40	54	64	89
	E	mm		27	35	45	65
	F	mm		42	48	55	63
	G	mm		4	5	5	5
	H	10	mm		70	85	105



 max. 0,75°

 ←A150			Type NFS				
			25	38	45	65	
	1	∅ max.	mm	25	38	45	65
		∅ min.	mm	0	0	0	26
	2	Tn	Nm	200	450	800	2000
		Tp		400	900	1600	4000
	3.3	tr/min omw/min rpm min <sup>-1</sup>					
	—	degré graad degree grad		0,75	0,75	0,75	0,75
	4	J (WR <sup>2</sup> )	kgm <sup>2</sup>	0,0004	0,0013	0,0026	0,0102
	5		kg	0,85	1,81	2,97	7,23
	6		dm <sup>3</sup>	0,01	0,02	0,03	0,05
mm: ±	A		mm	58	75	95	135
	B		mm	76,5	94	109	134,5
	C		mm	57,5	74,5	86	111,5
	D		mm	40	54	64	89
	E		mm	27	35	45	65
	F		mm	42	48	55	63
	G		mm	4	5	5	5
(min)	H	10	mm	70	85	105	135
	S	8	mm	60	70	90	130

## HOW TO SELECT THE RIGHT COUPLING SIZE

A. Select the size of ESCOGEAR coupling that will accommodate the largest shaft diameter.

B. Make sure this coupling has the required torque capacity according to following formula:  $\text{torque in Nm} = \frac{9550 \times P \times F_u \times F_{\text{ex}}}{n}$

P = power in kW; n = speed in rpm;  $F_u$  = service factor according to tabulation 1.

$F_{\text{ex}} = 2$  in case of use in potentially explosive atmospheres (Ex), European Directive 94/9/EC. In normal atmospheres,  $F_{\text{ex}} = 1$ .

The coupling selected per (A) must have an equal or greater torque capacity than the result of the formula (B). If not select a larger size coupling. Check if application peak torque does not exceed tabulated peak torque  $T_p$  indicated planographs A210 and A211.

Check also max. allowable misalignment using the graph of tabulations 1 and 2.

C. Check if shaft/hub connection will transmit the torque. If necessary, select a longer hub.

D. Read carefully assembly and maintenance instructions IM.

TABULATION 1		APPLICATIONS	DRIVER MACHINE		
			Electric motors Turbines	Hydraulic motors Gears drivers	Reciprocating engine Electric motors frequent starts
DRIVEN MACHINE	UNIFORM	Generators - Blowers: centrifugal vane, fans - Centrifugal pumps and compressors - Machine tools: auxiliary drives - Conveyors: belt and chain, uniformly loaded, escalators - Can filling machines and bottling machinery - Agitators: pure liquids.	0,8 to 1,25	1 to 1,5	1,25 to 1,75
		Propeller - Waterjet pumps	1,25	1,5	1,75
	MODERATE SHOCKS	Blowers: lobe - Pumps: gear and lobe types - Vane compressors - Machine tools: main drives - Conveyors: belt and chain not uniformly fed bucket and screw - Elevators, cranes, tackles and winches - Wire winding machines, reels, winders (paper industry) - Agitators liquids and solids, liquids variable density.	1,25 to 1,5	1,5 to 1,75	1,75 to 2
	HEAVY SHOCKS	Generators (welding) - Reciprocating pumps and compressors - Laundry washers - Bending roll, punch press, tapping machines - Barkers, calanders, paper presses - Briquetter machines, cement furnace - Crushers: ore and stone, hammer mill, rubber mill - Metal mills: forming machines, table conveyors - Draw Bench, wire drawing and flattening machines - Road & railroad equipment.	1,5 to 2	1,75 to 2,25	2 to 2,5

TABULATION 2

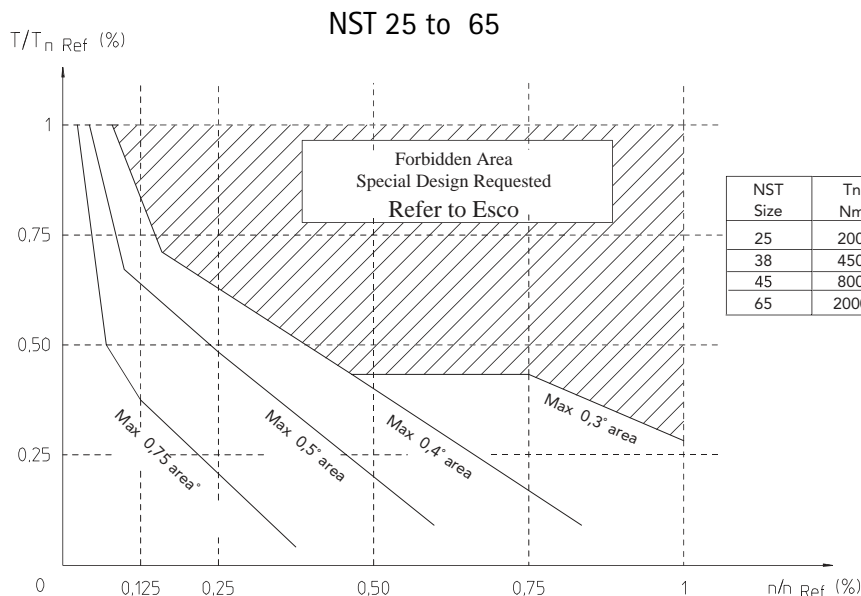











### HOW TO USE THE GRAPH ?

Maximum torque, maximum speed and maximum misalignment may not occur simultaneously.

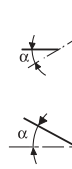
Graph must be used as follows:

1. Calculate  $T_n$  and  $T_p$  and select coupling size as usual.  $T_n$  = nominal torque;  $T_p$  = peak torque
2. Calculate  $T_n/T_n\text{Ref}$  and  $n/n\text{Ref}$  and plot the resulting point in the graph.
3. If the resulting point is located in the white area, a standard coupling may be used as far as maximum misalignment doesn't exceed the maximum misalignment indicated in the graph.
4. If the resulting point is located in the shaded area, refer to ESCO
5. In case of use in potentially explosive atmospheres (Ex), proceed the same way but using  $T_n\text{Ref(Ex)}$  for the calculation. Max misalignment may not exceed 0,5° per gear mesh.

LEGEND OF USED PICTOGRAMS		Notes for series N
	d Ø nominal max.	MAXIMUM NOMINAL BORE (mm)
	d Ø min.	MINIMUM BORE (mm)
	d Ø max.	MAXIMUM BORE (mm)
	Tn	MAXIMUM NOMINAL TORQUE (Nm)
	Tp	MAXIMUM PEAK TORQUE (Nm)
		MAXIMUM SPEED (rpm)
		MAXIMUM OFFSET (mm)
		MAXIMUM ANGULAR MISALIGNMENT (degree)
		INERTIA (kgm²)
		WEIGHT (kg)
		GREASE QUANTITY (dm³)

- 1 For key according to ISO R 773.
- 2 Gear maximum continuous transmissible torque for the tabulated misalignment. The effective transmissible torque depends on the bore and shaft/hub connection.
- 3 Higher speed on special request.
- 3.1 For grease withstanding centrifugal acceleration of 1.000g. See installation and maintenance manual IM.
- 3.2 For grease withstanding centrifugal acceleration of 2.000g. See installation and maintenance manual IM.
- 3.3 Depends on S.
- 3.4 For long operation in disconnected position contact us.
- 4 For solid bore.
- 4.1 Depends on S.
- 4.2 For solid bore and S minimum.
- 4.3 Per 100 mm spacer length.
- 4.4 Depends on L and R.
- 5 For pilot bored hubs.
- 5.1 Depends on S.
- 5.2 For pilot bored hubs and S minimum.
- 5.3 Per 100 mm spacer length.
- 5.4 Depends on L and R.
- 6 See installation and maintenance manual IM.
- 6.1 Depends on S. Values given for S maximum.
- 7 On request. For larger S contact us.
- 8 Values for S minimum. S maximum depends on torque and speed.
- 9 G must remain constant during operation.
- 10 Needed to control the alignment and inspect the gears.

\* Max. torque, speed and misalignment tabulated values may not be cumulated. See IM/A200.

